

EXTRÉMITÉS DE PONCEAUX

2400mm Ø

Bloc joint à faire en
chantier

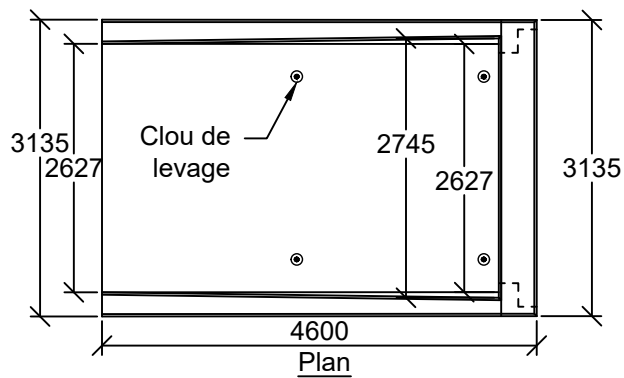
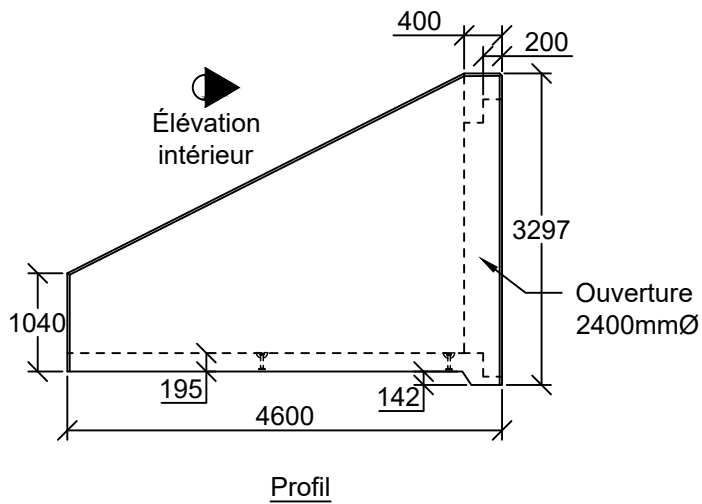
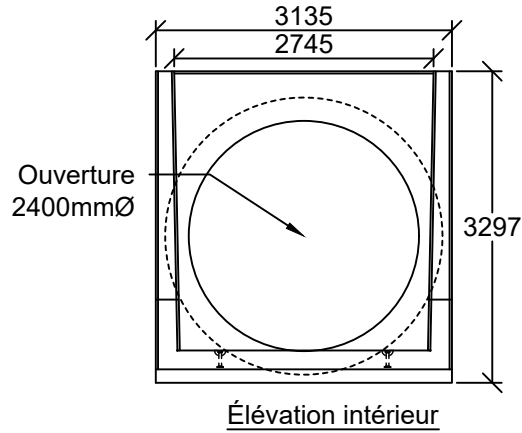

Poids :
2400mmØ : ±21 000kg