

APPAREIL DE LEVAGE

Regard rectangulaire

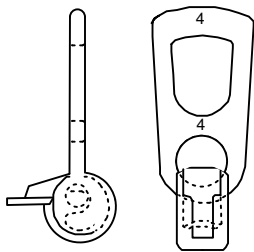

MAIN DE LEVAGE

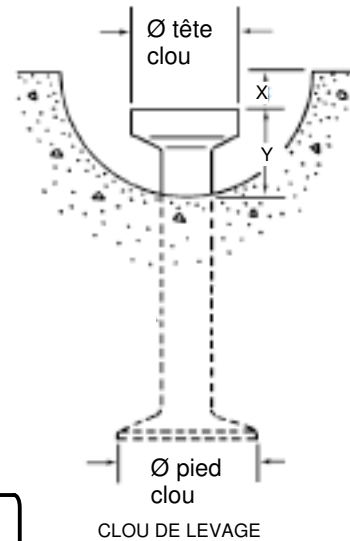
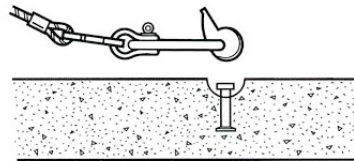
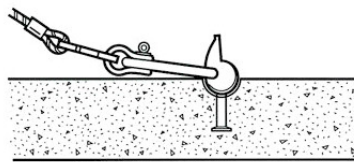
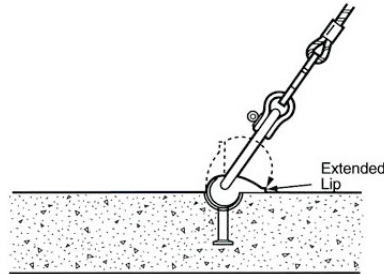

CLOU DE LEVAGE

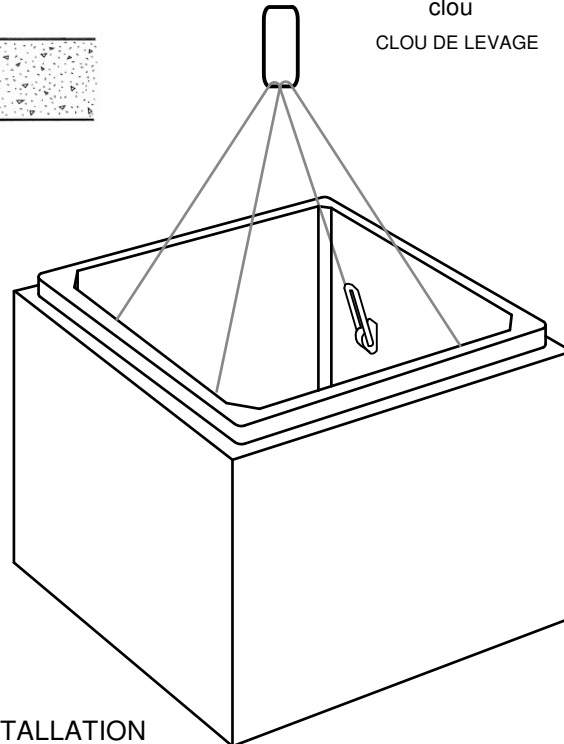
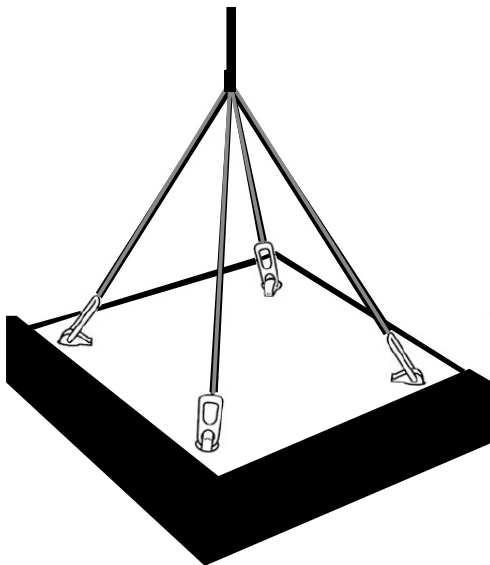

EXEMPLE D'INSTALLATION

fortier2000.com
Saint-Henri-de-Lévis (Qc)
#Tél.: 418-882-2205

tuvico.com
Laterrière (Qc)
#Tél.: 418-696-0696